

# SPARE PARTS BOOK

EL PRIMA

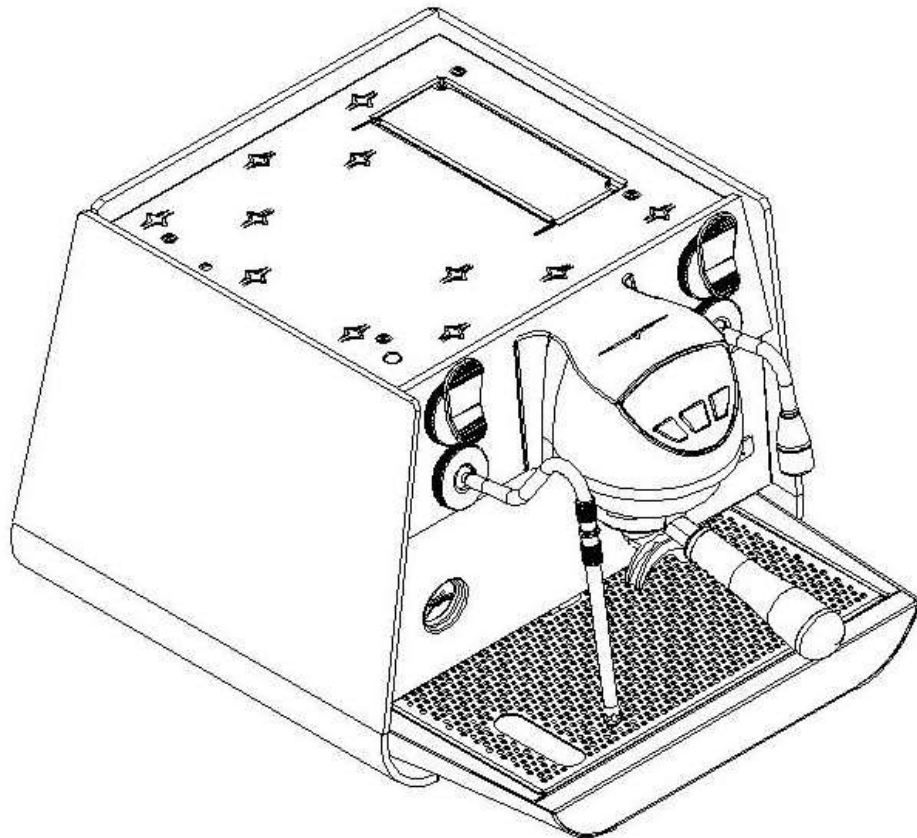

28/01/2025

---

*Victoria Arduino*

INSPIRED BY YOUR PASSION.



INSPIRED BY YOUR PASSION.

- T.01 **CABINET PARTS**  
COMPONENTI GRUPPO CARENA
- T.02 **CONTROL PANEL PARTS**  
COMPONENTI INVOLUCRO COMANDI
- T.03 **POURING GROUP PARTS**  
COMPONENTI GRUPPO EROGAZIONE
- T.04 **HYDRAULIC PARTS**  
COMPONENTI IDRAULICI
- T.05 **STEAM & HOT WATER PARTS**  
COMP. VAPORE E ACQUA CALDA
- T.06 **EASY CREAM PARTS**  
COMPONENTI EASY CREAM
- T.07 **HYDRAULIC GROUP PARTS**  
COMPONENTI GRUPPO IDRAULICO
- T.08 **BOILER PARTS**  
COMPONENTI CALDAIA
- T.09 **FRAME PARTS**  
COMPONENTI TELAIO
- T.10 **ELECTRONIC & ELECTRICAL PARTS**  
COMP. ELETTRICI ED ELETTRONICI

» LEGEND :

THE CODES WRITTEN IN BOLD REFER TO THE COMPONENTS  
EMPLOYED CURRENTLY.

THE CODES USED BEFORE ARE WRITTEN IN CORSIVE WITH INDICATED,  
ON THE SIDE, THE END OF VALIDITY DATE.

EXAMPLE:

*03001531 - 01/09/2007*

**03001531**

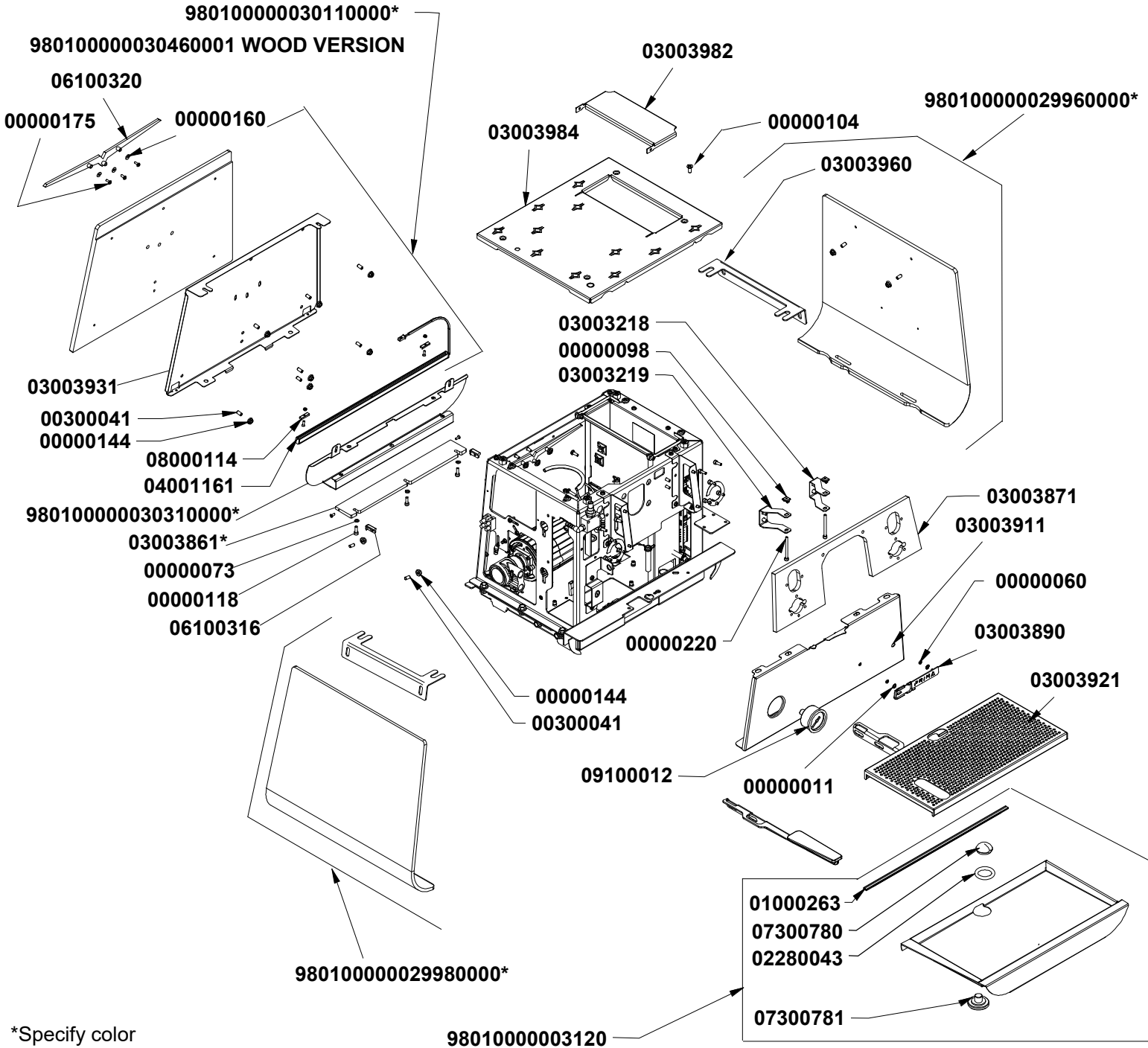

COD.	DESCRIPTION	DESCRIZIONE	VAL.
00000011	S/S KNURLED WASHER M4 UNI8842/A	RONDELLA INOX M4 ZIGRINATA UNI8842/A	
00000060	GALV MEDIUM NUT AQ M3	DADO AQ M3 MEDIO ZINCATO	
00000073	S/S WASHER D.8x4x1 UNI6592	RONDELLA INOX 8x4x1 UNI6592	
00000098	CAGE NUT M4 T424 SPESS. 1,7-2,3	DADO IN GABBIA M 4 T424 x SPESS. 1,7-2,3	
00000104	S/S CROSSHEAD COUNTERSUNK SCREW M4x10 DIN965	VITE INOX M4x10 TSP TCR DIN965	
00000118	S/SHEX SOCKET CAP SCREW M4x12 5931	VITE INOX M4x12 TCEI 5931	
00000144	GALV FLANGED NUT M5 UNI 6923	DADO AQ M5 FLANGIATO ZINC. UNI6923	
00000160	S/S WASHER D4X12 UNI 6593	RONDELLA INOX D4x12x1 UNI 6593	
00000175	S/S CROSS HEAD CAP SCREW M4X10	VITE INOX M4x10 TC TCR	
00000220	S/S SOCKET SCREW M4x45 FULLY THREADED	VITE INOX M4x45 TCEI FILETTO PARZIALE	
00300041	S/S FH GRUB SCREW M5X10	GRANO INOX M5x10 PUNTA PIANA	
01000263	RUBBER PROFILE GASKET FOR PLATE	GUARNIZIONE PROFILO IN GOMMA PER PIATTO	
02280043	GASKET OR 9,50x2,00 EP851	GUARN. OR 9,50x2,00 EP851	
03003218	RIGHT SUPPORT COVER GROUP VA388	LAMIERA DX SUPP. COPRIGRUPPO VA	
03003219	LEFT SUPPORT COVER GROUP VA388	LAMIERA SX SUPP. COPRIGRUPPO VA	
03003861	REAR INFERIOR PROFILE EAGLE ONE 1GR ALLUMINUM	PROFILO RETRO INFERIORE 1GR EAGLE ONE ALLUMINIO	
03003871	FRONTAL PANEL 1GR EAGLE ONE CHROMED ALLUMINUM	PARETE FRONTALE 1GR EAGLE ONE ALLUMINIO CROMATO	
03003890	FRONTSIDE LOGO EAGLE ONE PRIMA	LOGO FRONTALE EAGLE ONE PRIMA	
03003911	INF FRONT PLATE 1GR EAGLE ONE	PARETE FRONTALE INF. 1GR EAGLE ONE	
03003921	WORKTOP NET 1GR EAGLE	RETINA PIANO LAVORO 1GR. EAGLE	
03003931	SUP BACK PANEL SUPPORT 1GR	SUPPORTO CARENA RETRO SUPERIORE 1GR EAGLE	
03003960	SUPERIOR SIDE PLATE FRAME SUPPORT E1 PRIMA	LAMIERA SUP. SUPPORTO FIANCO CARENA EAGLE ONE 1GR	
03003982	TANK COVER 1GR.	COPERCHIO TANICA EAGLE ONE 1GR.	
03003984	SUPERIOR CUPHOLDER EAGLE ONE 1GR	PORTATAZZE SUPERIORE EAGLE ONE 1GR.	
04001161	STRIP LED EAGLE ONE 1GR.	STRIP LED EAGLE ONE 1GR.	
06100316	LEFT TERMINAL INF. BACKSIDE PROFILE	TERMINALE SX PROFILO RETRO INFERIORE EAGLE ONE 1GR	
06100320	REAR EAGLE LOGO STEELUX	LOGO AQUILA POSTERIORE EAGLE ONE 1GR. ALL. LUCIDO	
07300780	DRIP TRAY CAP EAGLE ONE 1GR	TAPPO VASCHETTA EAGLE ONE 1GR	
07300781	SCREW FOR DRIP TRAY CAP EAGLE ONE 1GR	VITE PER TAPPO VASCHETTA EAGLE ONE 1GR	
08000114	FIXING SPRING REAR LED EAGLE ONE	MOLLA FISSAGGIO LED POSTERIORE EAGLE ONE	
09100012	PRESSURE GAUGE SCALE 0-4 BAR 1/8 D.40 V.A. PRIMA	MANOMETRO SCALA 0-4 BAR 1/8 D.40 V.A. PRIMA	
03003861.NOV	REAR INFERIOR PROFILE MATT BLACK	PROFILO RETRO INFERIORE 1GR EAGLE ONE NERO OPACO	
03003861.BV	REAR INFERIOR PROFILE WHITE	PROFILO RETRO INFERIORE 1GR EAGLE ONE BIANCORAL	
98010000029960001	RIGHT SIDE 1GR STEELUX	ASSIEME FIANCO DX 1GR. STEELUX	
98010000029960002	RIGHT SIDE PANEL 1GR. MATT BLACK	ASSIEME FIANCO DX 1GR. NERO OPACO	
98010000029960003	RIGHT SIDE PANEL 1GR. WHITE	ASSIEME FIANCO DX 1GR. BIANCO OPACO	
98010000029960004	RIGHT SIDE PANEL 1GR. RED CAPPELLINI	ASSIEME FIANCO DX 1GR. ROSSO CAPPELLINI	
98010000029960006	RIGHT SIDE PANEL 1GR. BLUE CAPPELLINI	ASSIEME FIANCO DX 1GR. BLU CAPPELLINI	
98010000029960011	RIGHT SIDE PANEL MUSTARD CAPPELLINI	ASS. FIANCO DX CAPPELLINI SENAPE	
98010000029960010	RIGHT SIDE PANEL BROWN CAPPELLINI	ASS. FIANCO DX CAPPELLINI MARRONE	
98010000029960012	RIGHT SIDE PANEL DOVE-GREY CAPPELLINI	ASS. FIANCO DX CAPPELLINI TORTORA	
98010000029980002	LEFT SIDE PANEL 1GR. MATT BLACK	ASSIEME FIANCO SX 1GR. NERO OPACO	
98010000029980003	LEFT SIDE PANEL 1GR. WHITE	ASSIEME FIANCO SX 1GR. BIANCO OPACO	
98010000029980001	LEFT SIDE SET 1GR STEELUX	ASSIEME FIANCO SX 1GR. STEELUX	
98010000029980004	LEFT SIDE PANEL 1GR. RED CAPPELLINI	ASSIEME FIANCO SX 1GR. ROSSO CAPPELLINI	
98010000029980006	LEFT SIDE PANEL 1GR. BLUE CAPPELLINI	ASSIEME FIANCO SX 1GR. BLU CAPPELLINI	
98010000029980010	LEFT SIDE PANEL BROWN CAPPELLINI	ASS. FIANCO SX CAPPELLINI MARRONE	

COD.	DESCRIPTION	DESCRIZIONE	VAL.
980100000029980011	LEFT SIDE PANEL MUSTARD CAPPELLINI	ASS. FIANCO SX CAPPELLINI SENAPE	
980100000030110001	BACK FRAME SET EAGLE ONE 1GR. STEELUX WITH LIGH	ASS. CARENA RETRO 1GR. STEELUX CON LUCI	
980100000029980012	LEFT SIDE PANEL DOVE-GREY CAPPELLINI	ASS. FIANCO SX CAPPELLINI TORTORA	
980100000030110003	REAR PANEL ASS. 1 GR. WHITE WITH LIGHTS	ASS. CARENA RETRO 1GR. BIANCO OPACO CON LUCI	
980100000030110004	REAR PANEL ASS. 1 GR. CAPPELLINI RED WITH LIGHTS	ASS. CARENA RETRO 1GR. ROSSO CAPPELLINI CON LUCI	
980100000030110006	REAR PANEL ASS. 1 GR. CAPPELLINI BLUE WITH LIGHTS	ASS. CARENA RETRO 1GR. BLU CAPPELLINI CON LUCI	
980100000030110008	REAR PANEL ASSEMBLY BROWN CAPPELLINI WITH LIGH	ASS. CARENA RETRO 1GR. MARRONE CAPPELLINI CON LU	
980100000030110002	REAR PANEL ASS. 1 GR. MATT BLACK WITH LIGHTS	ASS. CARENA RETRO 1GR. NERO OPACO CON LUCI	
980100000030110009	REAR PANEL ASSEMBLY MUSTARD CAPPELLINI WITH LIG	ASS. CARENA RETRO 1GR. SENAPE CAPPELLINI CON LUC	
980100000030310001	INFERIOR RETRO FRAME SET 1GR STEELUX	ASSIEME CARENA RETRO INF. STEELUX	
980100000030310002	INFERIOR RETRO FRAME SET 1GR MATT BLACK	ASSIEME CARENA RETRO INF. NERO OPACO	
980100000030110010	REAR PANEL ASSEMBLY DOVE-GREY CAPPELLINI WITH L	ASS. CARENA RETRO 1GR. TORTORA CAPPELLINI CON LU	
980100000030460001	WOOD BACK PANEL ASSEMBLY 1GR	ASS. CARENA RETRO EAGLE ONE 1GR. LEGNO	
980100000030610001	INFERIOR REAR PROFIL CAPPELLINI RED	PROFILO RETRO INF. CAPPELLINI ROSSO	
980100000030610002	INFERIOR REAR PROFIL CAPPELLINI GREEN	PROFILO RETRO INF. CAPPELLINI VERDE	
980100000030610003	INFERIOR REAR PROFIL CAPPELLINI BLUE	PROFILO RETRO INF. CAPPELLINI BLU	
980100000030610007	INFERIOR REAR PROFIL BROWN CAPPELLINI	PROFILO RETRO INF. CAPPELLINI MARRONE	
980100000030610008	INFERIOR REAR PROFIL MUSTARD CAPPELLINI	PROFILO RETRO INF. CAPPELLINI SENAPE	
980100000030610009	INFERIOR REAR PROFIL DOVE-GREY CAPPELLINI	PROFILO RETRO INF. CAPPELLINI TORTORA	
98010000003120	COMPLETE WATER COLLECTION PLATE ASS. WITH HOLE	ASS. PIATTO RACC.ACQUA CON FORO COMPL. E1 PRIMA	

06100300

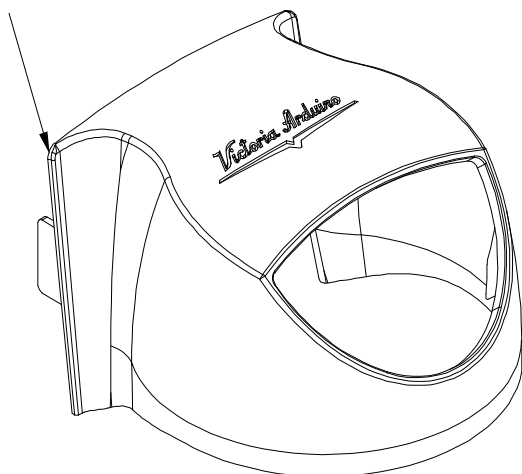

00000113

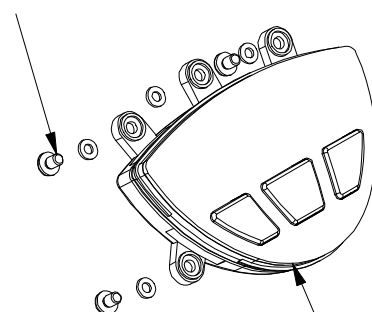

04901501

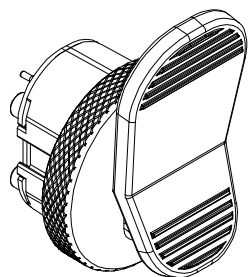

9806000000514

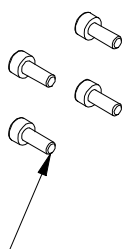

00000165

04901520

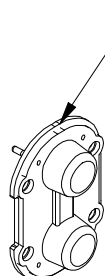

07300784

08000107

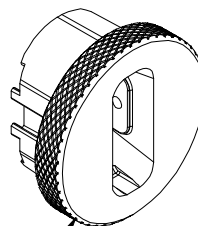
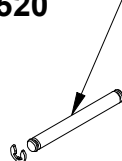

06100306

06100304

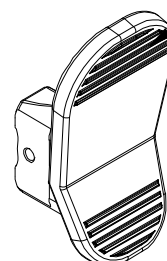

COD.	DESCRIPTION	DESCRIZIONE	VAL.
00000113	S/S CROS SHEAD CAP SCREW M4x6 7985	VITE INOX M4x6 TC TCR 7985	
00000165	S/S SCREW M3x8 TCEI ISO 4762	VITE INOX M3x8 TCEI ISO 4762	
04901501	DISPENSING BOARD EAGLE ONE 1GR	SCHEDA EROGAZ. EAGLE ONE 1GR	
04901520	ELECTR CNTRL BOARD W/ STEAM LEVER MAT EAGLE ON	SCHEDA ELETTR. CON TAPPETINO LEVA VAPORE EAGLE	
R04901520	KIT-ELECTR CNTRL BOARD W/ STEAM LEVER MAT - 1Pcs	KIT-SCHEDA ELETTR. CON TAPPETINO LEVA VAPORE- 1Pz	
06100300	GROUP COVER EAGLE ONE CHROME	COPRIGRUPPO CROMATO EAGLE ONE	
06100304	STEAM LEVER EAGLE ONE	LEVA VAPORE EAGLE ONE	
06100306	LEVER SUPPORT EAGLE ONE	SUPPORTO LEVA VAPORE EAGLE ONE	
07300784	STEAM LEVER LOCK PIVOT EAGLE ONE	PERNO BLOCCO LEVA VAPORE EAGLE ONE	
08000107	LOCKING SPRING FOR STEAM TAP EAGLE ONE	SEEGER BLOCCO LEVA VAPORE EAGLE ONE	
98060000000514	STEAM KNOB SET EAGLE ONE	ASS. MANOPOLA VAPORE EAGLE ONE	

\*\* North America Market

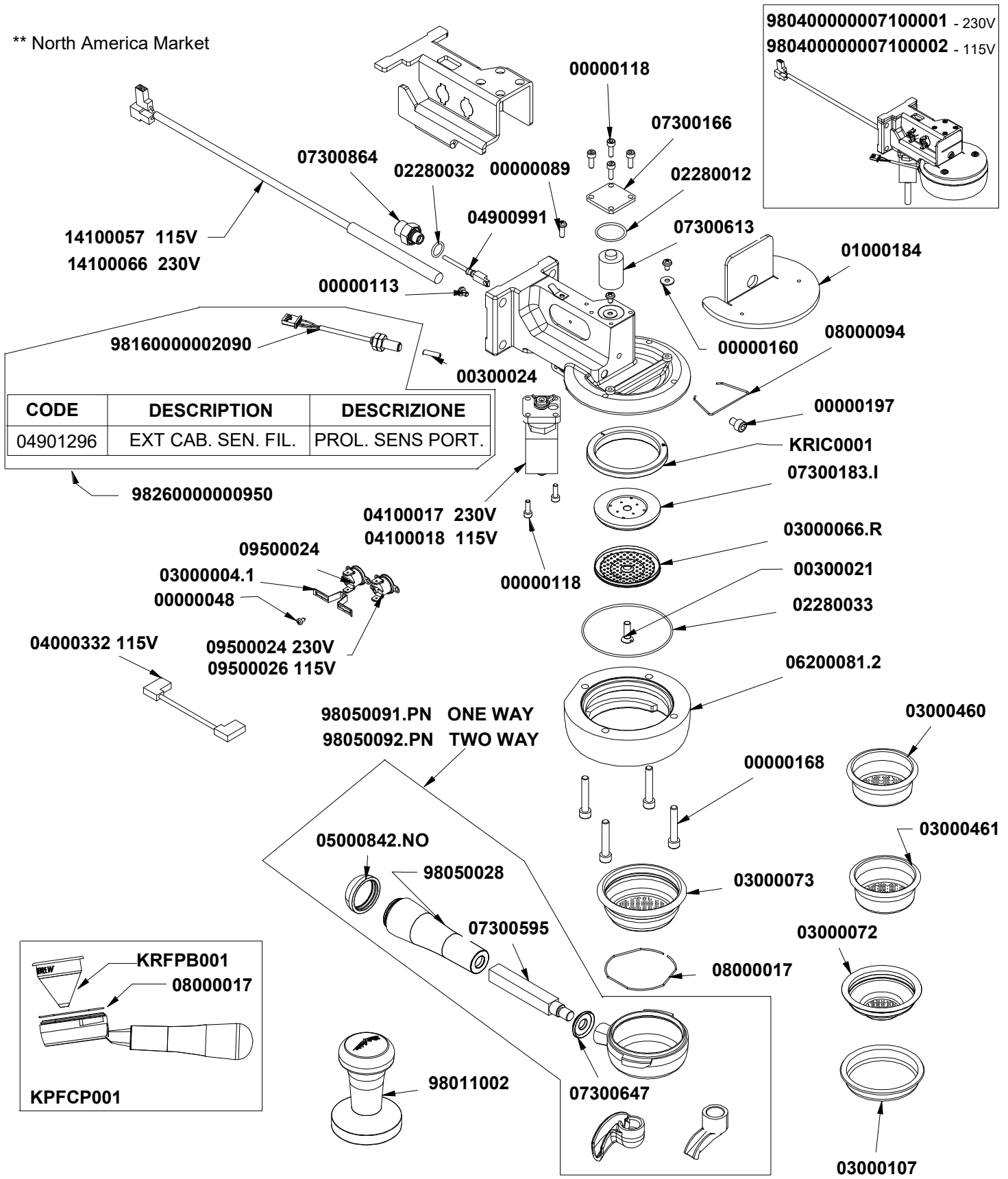

COD.	DESCRIPTION	DESCRIZIONE	VAL.
00000048	SELF-TAPPING SCREW 2.9x4.5 TC/T.CR.	VITE AUTOF 2,9x4,5 TC/T.CR.	
00000089	S/S CROSSHEAD CAP SCREW M4x12 DIN7985	VITE INOX M4x12 TC TCR DIN7985	
00000113	S/S CROS SHEAD CAP SCREW M4x6 7985	VITE INOX M4x6 TC TCR 7985	
00000118	S/SHEX SOCKET CAP SCREW M4x12 5931	VITE INOX M4x12 TCEI 5931	
00000160	S/S WASHER D4X12 UNI 6593	RONDELLA INOX D4x12x1 UNI 6593	
00000168	S/S HEXAGON SOCKET HEAD SCREW M6x35 UNI 5931	VITE INOX M6x35 TCEI 5931	
00000197	S/S HEX SOCKET CAP SCREW M6x8 ISO 4762	VITE INOX M6x8 TCEI ISO 4762	
00300021	S/S SLT COUNTERSUNK SCREW M6X18 DIN963	VITE INOX M6x18 TSP TC DIN963	
R00300021	KIT-S/S SLT COUNTERSUNK SCREW M6X18 - 30Pcs	KIT-VITE INOX M6x18 - 30Pz	
00300024	S/S GRUB SCREW M4X16 5923	GRANO INOX M4x16 5923	
01000184	ADONIS GROUP INSULATOR	ISOLANTE GRUPPO EROGAZIONE ADONIS	
02280012	GASKET O RING 2093 D.27 EP851	GUARN. OR 2093 D.27 VITON DF 801	
R02280012	KIT-GASKET O RING 2093 D.27 EP - 30Pcs	KIT-GUARN. OR D.27 VITON DF - 30Pz	
02280032	GASKET O RING 114 D15 EP 851	GUARN. OR 114 D.15 EP 851	
R02280032	KIT-GASKET O RING 114 D15 EP - 25Pcs	KIT-GUARN. OR 114 D.15 EP - 25Pz	
R02280033	KIT-GASKET O RING 75,92x1,78 NBR - 20Pcs	KIT-GUARN. OR 75,92x1,78 NBR - 20Pz	
02280033	GASKET O RING 75,92x1,78 NBR XP70	GUARN. OR 75,92x1,78 NBR XP70 2300	
03000004.1	DOUBLE BRACKET FOR THERMOSTAT	STAFFA DOPPIA x TERMOSTATO	
03000066.R	S/S SHOWER REINFORCED	DOCCIA INOX RINFORZATA Aisi304	
R03000066.R	KIT-S/S SHOWER REINFORCED - 4Pcs	KIT-DOCCIA INOX RINFORZATA Aisi304 - 4Pz	
03000072	FILTER ONE COFFEE HIGH 7gr	FILTRO 1 CAFFE' ALTO 7gr.	
R03000072	KIT-FILTER ONE COFFEE HIGH 7gr - 3Pcs	KIT-FILTRO 1 CAFFE' ALTO 7gr. - 3Pz	
03000073	FILTER TWO COFFEE HIGH 14gr	FILTRO 2 CAFFE' ALTO 14gr.	
R03000073	KIT-FILTER TWO COFFEE HIGH 14gr - 3Pcs	KIT-FILTRO 2 CAFFE' ALTO 14gr. - 3Pz	
03000107	BLIND FILTER	FILTRO CIECO	
R03000107	KIT-BLIND FILTER - 8Pcs	KIT-FILTRO CIECO - 8Pz	
03000460	COFFEE FILTER 20GR (RIDGELESS)	FILTRO CAFFE' 20gr (RIDGELESS)	
03000461	COFFEE FILTER 18GR (RIDGELESS)	FILTRO CAFFE' 18gr (RIDGELESS)	
04000332	EXT L=85 + FASTON F-F A FLAG AWG18 BROWN	CAVALLOTTO L=85 + FASTON F-F A BANDIERA AWG18MAR	
R04100017	KIT-3WAY SOLENOID DIS BASE 1/8220-230V50/60Hzz - 1Pc	KIT-E.V. NC 3VIE BASETTA SCAR. 1/8220-230V 50/60Hz- 1Pz	
04100017	3WAY SOLENOID DIS BASE 1/8220-230V50/60Hzz F1.5 CE	E.V. NC 3VIE BASETTA SCAR. 1/8220-230V 50/60HzRUBY F1	
04100018	3WAY SOLENOID DIS BASE 1/8110-120V60Hz F1.6 UL	E.V. NC 3VIE BASETTA SCAR. 1/8110-120V 60Hz RUBYF1.6 U	
04900991	GROUP TEMPERATURE PROBE PT1000 AURELIAII TFT	SONDA TEMPERATURA PT1000 GR. AURELIA II "DISPLAY A	
R04900991	KIT-GROUP TEMPERATURE PROBE PT1000 - 1Pcs	KIT-SONDA TEMPERATURA PT1000 - 1Pz	
05000842.NO	FILTER HOLDER KNOB LOCK 2003 PAINTED MATT BLACK	CHIUSURA MANOPOLA PORTAFILTRO 2003 VERN. NEROOF	
06200081.2	GR RING OR CHRME OT-58 - P.FILTER SENSOR EAGLE ON	ANELLO GRUPPO +SEDE OR CROMATO OT-58 PER SENSO	
07300166	FLANGE BLOCK LOCK SOLENOID HOLDER ADD.07.07.03	FLANGIA CHIUSURA BLOCCHETTO PORTA ELETTROV.AGG	
07300183.I	GROUP DIFFUSER h=3 S/S Aisi316	PADIGLIONE GRUPPO h=3 INOX Aisi316	
07300595	PORTAFILTER KNOB INSERT 2003 AVP ZINC.	INSERTO MANOPOLA PORTAFILTRO 2003 AVP ZINC.	
R07300595	KIT-PORTAFILTER KNOB INSERT 2003 AVP ZINC.-4Pcs	KIT -INSERTO MANOPOLA PORTAFILTRO 2003 AVP ZINC.-4Pz	
07300613	PRE INFUSION CHAMBER INSERT GROUP AURELIA OT-57	INSERTO CAMERA PRE-INFUSIONE GR. AURELIA OT-57	
R07300613	KIT-PRE INFUSION CHAMBER INSERT GROUP - 3Pcs	KIT-INSERTO CAMERA PRE-INFUSIONE GR. - 3Pz	
07300647	S/S WASHER PORTAFILTER KNOB DIFFUSER	RONDELLA INOX ROMPIGOCCIA MANOPOLA PORTAFILTRC	
07300864	FITTING 1/4M 1/8M + THREADED M6 Aisi316 + ORING POSI	RACCORDO 1/4M-1/8M + SEDE OR + F.M6 INOX Aisi316	
08000017	S/S FILTER LOCKING SPRING	MOLLA BLOCCA FILTRO ACC.INOX	
R08000017	KIT-S/S FILTER LOCKING SPRING - 15Pcs	KIT-MOLLA BLOCCA FILTRO ACC.INOX - 15Pz	
08000094	FAST. SPRING FOR INSULATION - DISP. GROUP	MOLLA FISSAGGIO ISOLANTE GR. EROGAZ. THERESIA -EA	

COD.	DESCRIPTION	DESCRIZIONE	VAL.
09500024	MANUAL THERMOSTAT 135°C TRIP FREE GREEN DRIPPIN	TERMOSTATO R.MAN. 135°C TRIP FREE GOCCIOLATURAVE	
09500026	AUTOMATIC THERMOSTAT 110°C	TERMOSTATO R.AUT. 110°C	
14100057	HEATING ELEMENT D10x115 300W 115V	RESISTENZA A CARTUCCIA D10x115 300W 115V	
R14100066	KIT-CARTRIDGE HEAT. ELEMENT D10x115 300W 230V - 1P	KIT-RESISTENZA A CARTUCCIA D10x115 300W 230V- 1Pz	
14100066	CARTRIDGE HEAT. ELEMENT D10x115 300W 230V	RESISTENZA A CARTUCCIA D10x115 300W 230V	
98011002	ANODISED COFFEE TAMPER BRILLIANT WHITE VA 2009	PRESSA CAFFE' ANOD.ARGENTO V.A. '09	
98040000007100001	DISPENSING GROUP SET 1GR. 230V	ASS. GR. EROG. EAGLE ONE 1GR. 230V	
98040000007100002	DISPENSING GROUP SET 1GR. 115V	ASS. GR. EROG. EAGLE ONE 1GR. 115V	
98050028	BLACK LEATHER PORTAFILTER HANDLE	MANOPOLA PORTAFILTRO IN PELLE NERA	
98050091.PN	S/S 1WAY PORTAFILTER IN BLACK LEATHER W/OUT FILT	CORPO PORTAFILTRO INOX 1 VIA + MANOP. PELLE NERA	
98050092.PN	S/S 2WAY PORTAFILTER IN BLACK LEATHER W/OUT FILT	CORPO PORTAFILTRO INOX 2 VIE + MANOP. PELLE NERA	
98160000002090	PORTAFILTER PRESENCE SENSOR AURELIA18 W/CONNE	SENSORE PRESENZA PORTAFILTRO AURELIA18 COMPL. D	
982600000000950	REPLACEMENT KIT FOR FILTER HOLDER SENSOR + EXTE	KIT RICAMBIO SENSORE PRESENZA PORTAFILTRO+PROLI	
KRIC0001	6pc PK LONGLIFE CONICA GASKET SHEATH AURELIA-VA3	CONFEZIONE 6pz. GUARNIZIONE SOTTOCOPPA CONICA LC	
04901296	EXT CABLE INDUCTIVE SENSOR PORTAFILTER AURELIA1	PROLUNGA SENSORE INDUTTIVO "PRESENZA PORTAFILT	
KPFCP001	COMP. PORTAFILTER CONE FILTER LEATHER BLK	PORTAFILTRO INCLIN.COMP. PURE BREW V.A.MANOPOLA	
KRFPB001	CONE FILTER PURE BREW	FILTRO CONO PURE BREW	

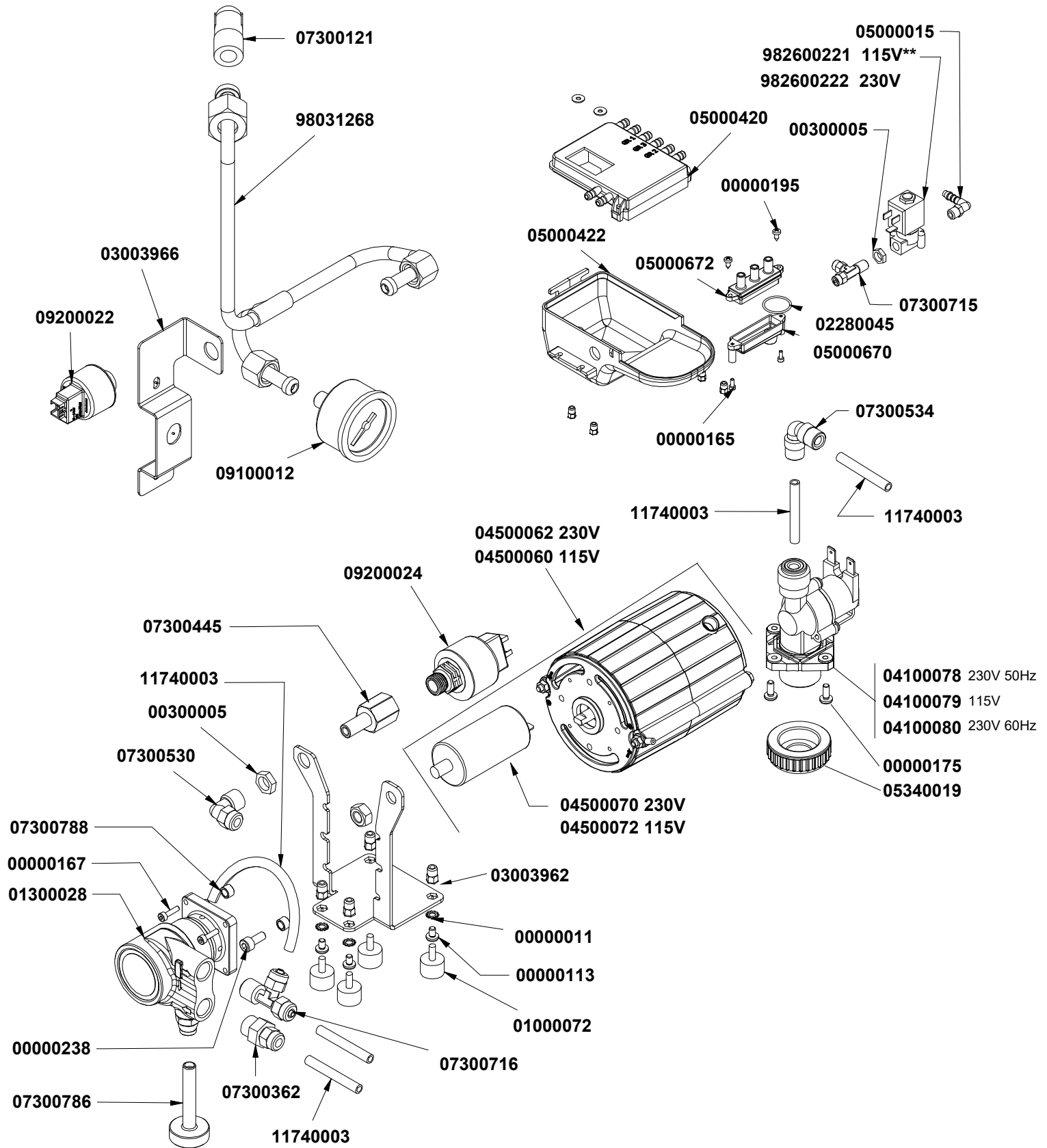

COD.	DESCRIPTION	DESCRIZIONE	VAL.
00000011	S/S KNURLED WASHER M4 UNI8842/A	RONDELLA INOX M4 ZIGRINATA UNI8842/A	
00000113	S/S CROSS HEAD CAP SCREW M4x6 7985	VITE INOX M4x6 TC TCR 7985	
00000165	S/S SCREW M3x8 TCEI ISO 4762	VITE INOX M3x8 TCEI ISO 4762	
00000167	S/S SCREW M3x12 TCEI ISO 4762	VITE INOX M3x12 TCEI ISO 4762	
00000175	S/S CROSS HEAD CAP SCREW M4X10	VITE INOX M4x10 TC TCR	
00000195	S/S SELF TAPPING SCREW 3,9X9,5 TC/TCR	VITE AUTOF INOX 3,9x9,5 TC TCR	
00000238	S/S SCREW M5X12 TCEI	VITE INOX M5x12 TCEI	
00300005	BRASS NUT 1/8 GAS D4 ADD 22.07.96 CH13	DADO OT 1/8 GAS AGG.22.07.96 SPESS.4 CH13	
01000072	ANTI-VIBRATING AD 10X10 M4 MM	ANTIVIBRANTE AD 10x10 M4 MM * KB *	
01300028	PUMP GA072	POMPANTE X POMPA ELETTROMECC. ACCIAIOGA072 70 L	
02280045	GASKET O RING 29,82x2,62 EPDM	GUARN. OR 29,82x2,62 EPDM	
03003962	PUMP SUPPORT BRACKET	STAFFA SUPPORTO POMPA EAGLE ONE 1GR	
03003966	MANOMETER SUPPORT BRACKET	STAFFA SUPPORTO MANOMETRO EAGLE ONE 1GR.	
04100078	SOLENOID NC 2WAY 3/4-JG 6 STRAIGHT REGUL.+FILTR F.	E.V. NC 2VIE 3/4-JG 6 DIRITTA REGOL+FILTR F.2,5230V 50/6	
04100079	SOLENOID NC 2WAY 3/4-JG 6 STRAIGHT REGUL.+FILTR F.	E.V. NC 2VIE 3/4-JG 6 DIRITTA REGOL+FILTR F.2,5115V 60H	
04100080	SOLENOID NC 2WAY 3/4-JG 6 STRAIGHT REGUL.+FILTR F.	E.V. NC 2VIE 3/4-JG 6 DIRIT. UL REGOL+FILTR F.2,5208/240V	
04500060	MOTOR 115V	MOTORE ELETTRICO 115V (x POMPA ELETTROMECC. GA072)	
04500062	ELECTRICAL ENGINE 230V (ELECTROMECC. PUMP GA072)	MOTORE ELETTRICO 230V (x POMPA ELETTROMECC. GA072)	
04500070	CAPACITOR 6,3 mF 450V FASTON 6,3	CONDENSATORE 6,3 mF 450V FASTON 6,3 CON CODOLOM	
04500072	CAPACITOR 25 mF 250V FASTON 6,3	CONDENSATORE 25 mF 250V FASTON 6,3 CON CODOLOM	
05000015	TUBE FASTENING WES 6R 1/8	RACCORDO PORTATUBO WES 6R 1/8	
05000420	TRAY PLUG UNDER PLATE VA388	TAPPO VASCHETTA SOTTO PIATTO VA388	
05000422	DRIP TRAY UNDER PLATED VA388	VASCHETTA SOTTO PIATTO VA388	
05000670	LOWER EXHAUST MANIFOLD	COLLETORE SCARICO INF. EAGLE ONE 1GR.	
05000672	UPPER EXHAUST MANIFOLD	COLLETORE SCARICO SUP. EAGLE ONE 1GR.	
05340019	BLACK TAP 3/4 W/ GASKET	TAPPO PL. 3/4 CON GUARNIZIONE	
07300121	FITTING L 1/4 M-M CYLIND ADD. 18.02.97	RACCORDO L 1/4 M-M CILINDRICOAGG. 18.02.97	
R07300121	KIT-FITTING L 1/4 M-M CYLIND - 8Pcs	KIT-RACCORDO L 1/4 M-M CILINDRICO - 8Pz	
07300362	STRAIGHT FITTING 1/4 M-FITTINGS.6 340	RACCORDO DIR. 1/4 M-CALZ.6 340	
07300445	FITTING 1/8M L = 20 1/4F for SENSOR	RACCORDO 1/8M L=20 1/4F x SENSORE	
07300530	FITTING L 1/8 F A CALZ. 347 6	RACCORDO L 1/8 F A CALZ. 347 6	
R07300530	KIT-FITTING L 1/8 F A CALZ. 347 6-5Pcs	KIT -RACCORDO L 1/8 F A CALZ. 347 6-5PZ** AD ESAURIME	
07300534	RAPID FITTING L D6 - D6	RACCORDO RAPIDO L D6 - D6	
07300715	T FITTING 1/8 M -FITTINGS.6 -FITTINGS.6	RACCORDO T 1/8 M -CALZAM.6 - CALZAM.6	
07300716	T FITTING 1/4 M -FITTINGS.6 -FITTINGS.6	RACCORDO T 1/4 M -CALZAM.6 - CALZAM.6	
07300786	PUMPING REGISTER KNOB	POMELLO REGISTRO POMPANTE EAGLE ONE 1GR	
07300788	STAINLESS STEEL BUSH 7,5x5,1 H5mm	BOCCOLA INOX 7,5x5,1 H5mm	
09100012	PRESSURE GAUGE SCALE 0-4 BAR 1/8 D.40 V.A. PRIMA	MANOMETRO SCALA 0-4 BAR 1/8 D.40 V.A. PRIMA	
09200022	PRESSURE TRANSDUCER 0-4 BAR 3/8	TRASDUTTORE DI PRESSIONE 0-4 BAR 3/8	
R09200022	KIT-PRESSURE TRANSDUCER 0-4 BAR 3/8-1Pcs	KIT -TRASDUTTORE DI PRESSIONE 0-4 BAR 3/8-1PZ	
09200024	PRESSURE TRANSDUCER 0-16 BAR 1/4	TRASDUTTORE DI PRESSIONE 0-16 BAR 1/4	
R09200024	KIT-PRESSURE TRANSDUCER 0-16 BAR 1/4-1Pcs	KIT -TRASDUTTORE DI PRESSIONE 0-16 BAR 1/4-1PZ	
11740003	CALIBRATED TEFLON PIPE 6/4	TUBO TEFLON NSF 6/4 CALIBRATO1 matassa = 50mt	
98031268	PRESSURE SENSOR HOSE	TUBO SENSORE PRESSIONE EAGLE ONE 1GR	
982600221	SPARE PARTS KIT E.V. 115V E1 PRIMA	KIT RICAMBIO E.V. 115V E1 PRIMA	
982600222	SPARE PARTS KIT E.V. 230V E1 PRIMA	KIT RICAMBIO E.V. 230V E1 PRIMA	

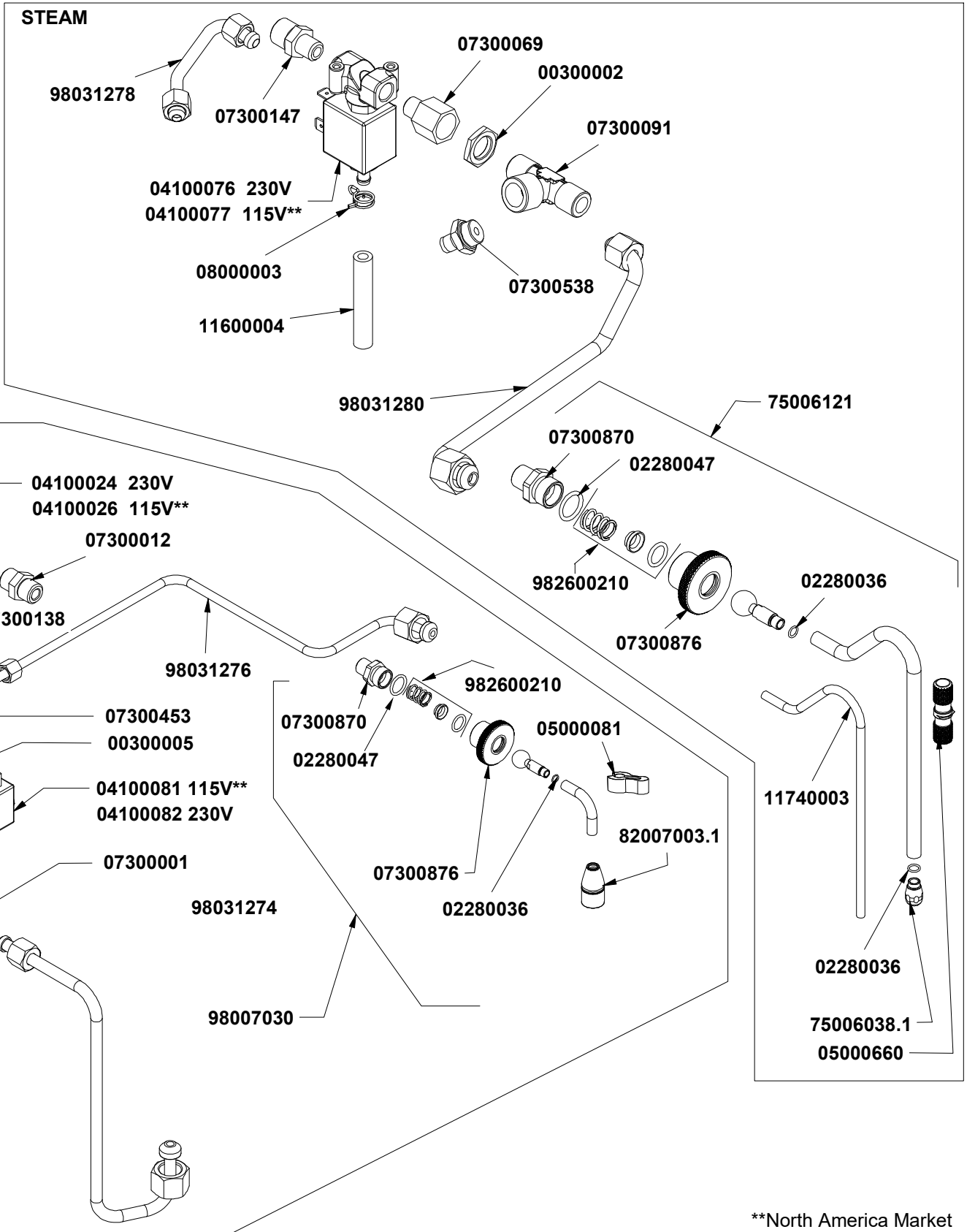

\*\*North America Market

COD.	DESCRIPTION	DESCRIZIONE	VAL.
05000081	WAND PROTECTION RUBBER D.10	GOMMINO PROTEZIONE LANCIA D.10 TIPO PINZA	
00300002	BRASS NUT 1/4 D3 CH18	DADO OT 1/4 SPESS.3 CH18 AGG. 22.07.96	
R00300002	KIT-BRASS NUT 1/4 D3 - 15Pcs	KIT-DADO OT 1/4 SPESS.3 - 15Pz	
00300005	BRASS NUT 1/8 GAS D4 ADD 22.07.96 CH13	DADO OT 1/8 GAS AGG.22.07.96 SPESS.4 CH13	
02280036	O RING FOR STEAM WAND NOZZLE D6x1.2 EPDM70 500 P	GUARN. OR x BECCO LANCIA VAP. DI 6x1.2 EPDM70(CONF.	
R02280036	KIT-O RING FOR STEAM WAND NOZZLE D6x1.2 EPDM - 65	KIT-GUARN. OR x BECCO LANCIA VAP. D. 6x1.2 EPDM- 65Pz	
02280047	O-RING GASKET 17,86X2,62 NBR	GUARN. OR 17,86x2,62 NBR	
04100024	3WAY SOLENOID 1/4 REGUL 90° 230V50/60Hz F3 CE	E.V. NC 2VIE 1/4 REGOLAT. 90° 230V 50/60Hz F.3 CE	
R04100024	KIT-3WAY SOLENOID 1/4 REGUL 90° 230V50/60Hz F3 CE -	KIT-E.V. NC 2VIE 1/4 REGOLAT. 90° 230V 50/60Hz F.3- 1Pz	
04100026	2WAY SOLENOID 1/4 REGUL 90° 115V 60Hz EPDM F3UL	E.V. NC 2VIE 1/4 REGOLAT. 90° 115V 60Hz EPDM F3 UL	
04100076	SOLENOID NC 3WAY 1/8-1/8 RUBBER CLAMP 220-230V 50/	E.V. NC 3VIE 1/8-1/8 PORTAG. 220-230V 50/60HzVITON F.2,5	
04100077	SOLENOID NC 3WAY 1/8-1/8 RUBBER CLAMP 115V 60HZ V	E.V. NC 3VIE 1/8-1/8 PORTAG. 115V 60HzVITON F.2,5 UL PIE	
04100081	SOL. VALVE 2 WAYS 1/8-1/8 100/120V 50/60HZ	E.V. NC 2VIE 1/8-1/8 100/120V 50/60Hz VITON F1.2UL-CSA NS	
04100082	SOLENOID NC 2WAY 1/8-1/8 220-230V 50/60HZ VITON F1.2	E.V. NC 2VIE 1/8-1/8 220-230V 50/60Hz VITON F1.2	
05000660	RUBBER PROTECTION STEAM WAND D.10	GOMMINO PROTEZIONE LANCIA D.10 EAGLE ONE	
07300001	L FITTING 1/8 M-M 459	RACCORDO L 1/8 M-M(dimens. L 24 mm)	
07300012	FITTING 1/4 1/4M-1/4M Aisi316	RACCORDO 1/4M-1/4M INOX Aisi316	
07300069	1/8" M 1/4" F FITTING ADD. 02.03.88	RACCORDO 1/8"M 1/4"F AGG. 02.03.88	
07300091	T FITTING MFM 1/4 CYLIN.	RACCORDO T 1/4 M-F-M CILIN.	
07300138	FITTING ADAPTER 1/4M-1/8F ES.17 AGG.29.05.96 OT-58	RIDUZIONE 1/4"M - 1/8"F ES.17 AGG. 29.05.96 OT-58	
07300147	FITTING 1/4 F.7 1/8 F.5 M-M AGG. 18.06.97	RACCORDO 1/4 F.7 1/8 F.5 M-M AGG. 18.06.97	
07300453	T FITTING 1/8 M-M-M	RACCORDO T 1/8 M-M-M	
07300538	RAPID FITTING 1/4 STRAIGHT D4	RACCORDO RAPIDO 1/4 DIRITTO D4	
07300870	JUNCTION 3/8 STEAM-WATER WAND EAGLE ONE	RACC. 3/8 LANCIA SNODATA VAPORE-ACQUA EAGLE ONE	
07300876	FIXING FERRULE STEAM-WATER WAND EAGLE ONE	GHIERA FISSAGGIO LANCIA VAPORE-ACQUA EAGLE ONE	
08000003	HOSE CLAMP D9,1	FASCETTA STRINGITUBO D9.1	
11600004	SILICONE PIPE 5x9 60Sh PEROX WHITE SEMITRASPAREN	TUBO SILICONE 5x9 70Sh PEROX TRASPARENTE(1mt=50gr)	
11740003	CALIBRATED TEFLON PIPE 6/4	TUBO TEFLON NSF 6/4 CALIBRATO1 matassa = 50mt	
75006038.1	STEAM NOOZLE M8,65X0,75 F1,2 ESAG.12	BECCO VAPORE M8,65x0,75 F. 1,2 ESAG.12	
75006121	SET COLD STEAM WAND EAGLE ONE 1GR.	KIT LANCIA VAPORE FREDDA EAGLE ONE 1GR.	
82007003.1	HOTWATER DIFFUSER D23,5 F1/8 WITH S/S AERATOR	ROMPIGETTO ACQUA CALDA D.23,5 F 1/8" CON AERATORE	
R82007003.1	KIT-HOTWATER DIFFUSER D23,5 F1/8 WITH S/S AERATOR	KIT-ROMPIGETTO ACQUA CALDA D.23,5 F 1/8" CON AERAT.	
98007030	S/S HOTWATER WAND KIT EAGLE ONE W/ DIFFUSER	KIT LANCIA ACQUA C. INOX EAGLE ONE COMPL. DIROMPIG	
98031274	PIPE - STEAMBOILER / HOT WATER SOLENOID VALVE	TUBO CALDAIA - E.V. ACQUA CALDA EAGLE ONE 1GR.	
98031276	HOT WATER WAND PIPE	TUBO LANCIA ACQUA CALDA EAGLE ONE 1GR.	
98031278	BOILER PIPE - STEAM SOLENOID VALVE	TUBO CALDAIA - E.V. VAPORE EAGLE ONE 1GR.	
98031280	STEAM SOLENOID-STEAM WAND PIPE	TUBO E.V. VAPORE - LANCIA VAPORE EAGLE ONE 1GR	
982600210	WAND KIT EAGLE ONE (OR-COMPASS-SPRING)	KIT RICAMBIO LANCIA EAGLE ONE (OR-BUSSOLA-MOLLA)	

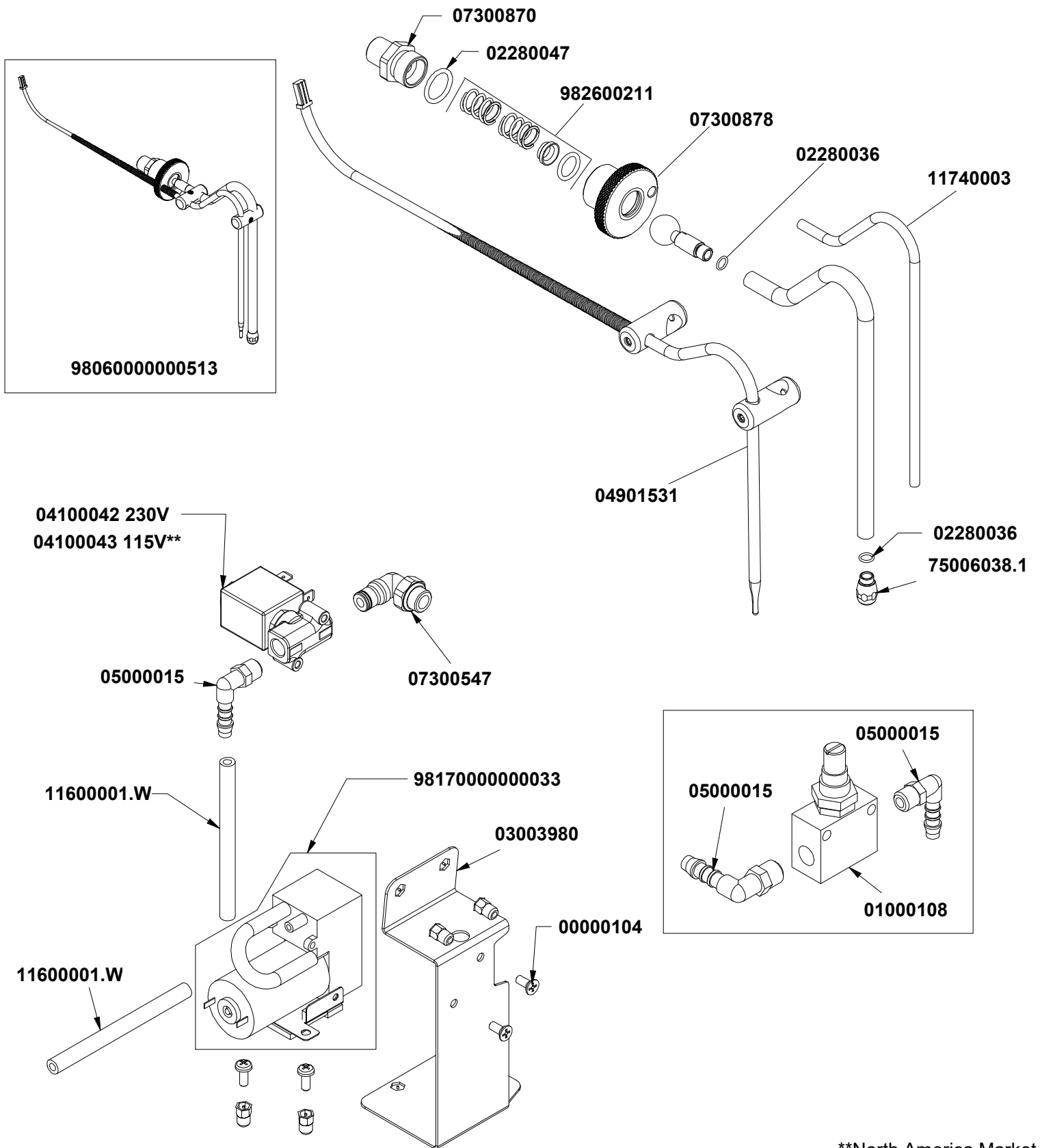

\*\*North America Market

COD.	DESCRIPTION	DESCRIZIONE	VAL.
00000104	S/S CROSSHEAD COUNTERSUNK SCREW M4x10 DIN965	VITE INOX M4x10 TSP TCR DIN965	
01000108	TAP MRF 1/8 FF 604	RUBINETTO MRF 1/8 F-F 604	
02280036	O RING FOR STEAM WAND NOZZLE D6x1.2 EPDM70 500 P	GUARN. OR x BECCO LANCIA VAP. DI 6x1.2 EPDM70(CONF.	
R02280036	KIT-O RING FOR STEAM WAND NOZZLE D6x1.2 EPDM - 65P	KIT-GUARN. OR x BECCO LANCIA VAP. D. 6x1.2 EPDM- 65Pz	
02280047	O-RING GASKET 17,86X2,62 NBR	GUARN. OR 17,86x2,62 NBR	
03003980	EASYCREAM SUPPORT	SUPPORTO COMPONENTI EASY CREAMEAGLE ONE 1GR	
04100042	2WAY SOLENOID 1/8-1/8 220-230V50/60Hz F2 CE TH1xM4	E.V. NC 2VIE 1/8-1/8 220-230V 50/60Hz VITON F2 CEPIEDINO	
R04100042	KIT-2WAY SOLENOID 1/8-1/8 220-230V50/60Hz F2 CE - 1Pcs	KIT-E.V. NC 2VIE 1/8-1/8 220-230V 50/60Hz VITON F2- 1Pz	
04100043	2WAY SOLENOID 1/8-1/8 110-120V 60Hz F2 UL TH1xM4	E.V. NC 2VIE 1/8-1/8 110-120V 60Hz VITON F2 ULPIEDINO FIL	
04901531	PT1000 PROBE FOR STEAM WAND	SONDA PT1000 x LANCIA VAPORE EAGLE ONE 1GR.+2 SUP	
05000015	TUBE FASTENING WES 6R 1/8	RACCORDO PORTATUBO WES 6R 1/8	
07300547	RAPID FITTING 1/8 L GIR. D4	RACCORDO RAPIDO 1/8 L GIR. D4	
07300870	JUNCTION 3/8 STEAM-WATER WAND EAGLE ONE	RACC. 3/8 LANCIA SNODATA VAPORE-ACQUA EAGLE ONE	
07300878	FIXING FERRULE STEAM WAND "EASY CREAM" EAGLE ON	GHIERA FISSAGGIO LANCIA VAPORE "EASY CREAM"EAGLE	
11600001.W	WHITE SILICONE PIPE 4x7,5 60Sh(1mt=41gr) PLATINICO SE	TUBO SILICONE BIANCO4x7,5 60Sh(1mt=41gr) PLATINICO SE	
11740003	CALIBRATED TEFLON PIPE 6/4	TUBO TEFLON NSF 6/4 CALIBRATO1 matassa = 50mt	
75006038.1	STEAM NOOZLE M8,65X0,75 F1,2 ESAG.12	BECCO VAPORE M8,65x0,75 F. 1,2 ESAG.12	
98060000000513	ASSEMBLY JOINT + EASY WAND WITH PROBE	ASS. ATTACCO + LANCIA EASY CREAM CON SONDAEAGLE	
98170000000033	MICROCOMPRESSOR + SUPPORT SET TALENTO	ASS. SUPPORTO + MICROCOMPRESSORE ARIA	
982600211	WAND KIT WER (OR-COMPASS-SPRING)	KIT RICAMBIO LANCIA EASY C. WER (OR-BUSSOLA-MOLLA	

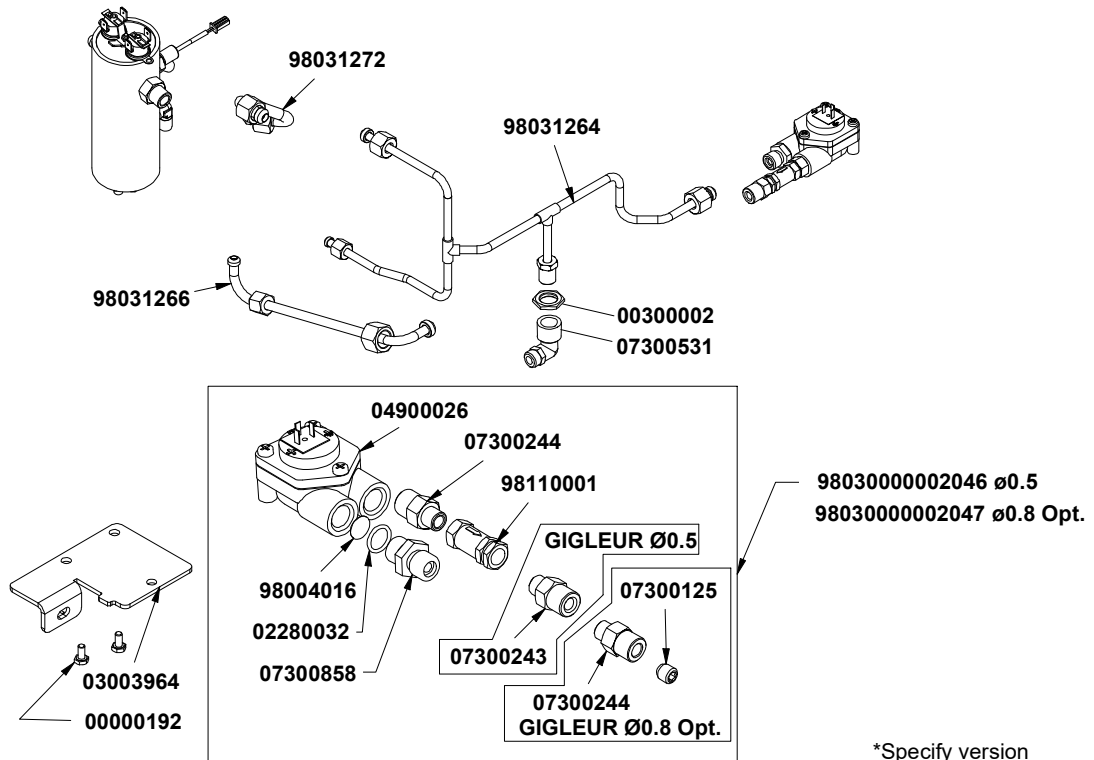

\*Specify version  
Specificare versione

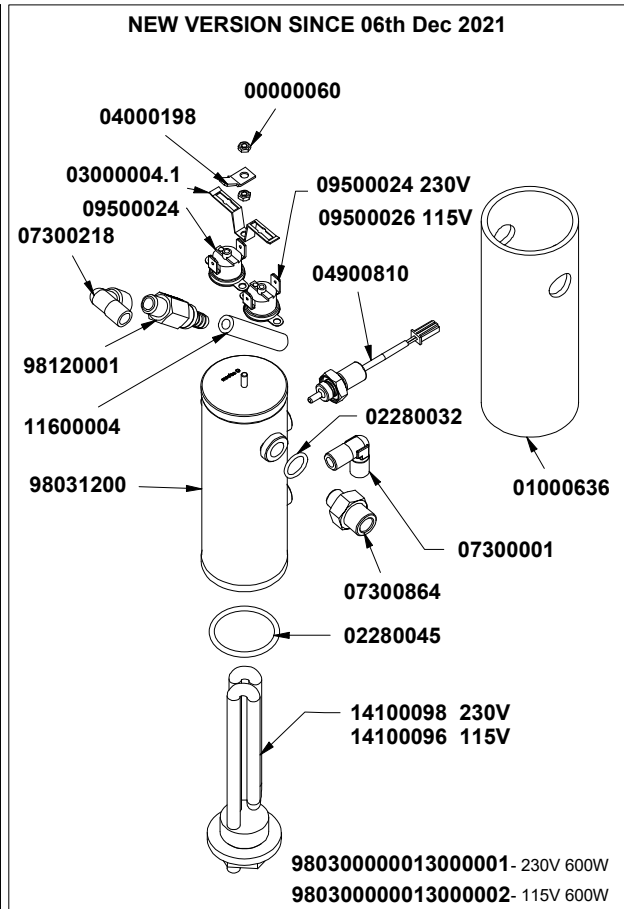
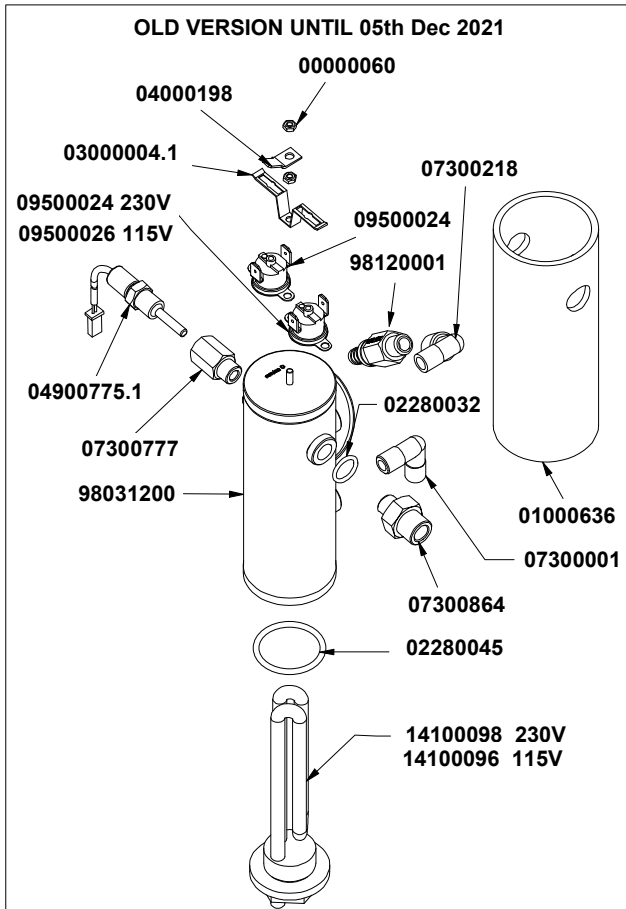

COD.	DESCRIPTION	DESCRIZIONE	VAL.
00000060	GALV MEDIUM NUT AQ M3	DADO AQ M3 MEDIO ZINCATO	
00000192	S/S SCREW M4x8 TE UNI 5739	VITE INOX M4x8 TE UNI 5739	
00300002	BRASS NUT 1/4 D3 CH18	DADO OT 1/4 SPESS.3 CH18 AGG. 22.07.96	
01000636	COFFEE BOILER INSULATION EAGLE ONE	ISOLANTE CALDAIA CAFFE' NEO	
02280032	GASKET O RING 114 D15 EP 851	GUARN. OR 114 D.15 EP 851	
R02280032	KIT-GASKET O RING 114 D15 EP - 25Pcs	KIT-GUARN. OR 114 D.15 EP - 25Pz	
02280045	GASKET O RING 29,82x2,62 EPDM	GUARN. OR 29,82x2,62 EPDM	
03000004.1	DOUBLE BRACKET FOR THERMOSTAT	STAFFA DOPPIA x TERMOSTATO	
03003964	SUPPORT DOSER BRACKET	LAMIERA SUPPORTO DOSATORE EAGLE ONE 1GR.	
04000198	FOIL HOLDER M 6.3 D 4.2 45°	PRESA LAMELLARE M 6.3 d4.2 45°	
04900026	BRASS FLOWMETER 1/4-1/4GAS -ATT. HEAD 2,8x0,5F 1,2 "	DOSATORE VOLUMETRICO OTT. 1/4-1/4GAS -ATT. TEST.2,8	
04900775.1	TEMPERATURE PROBE 150°NTC ATT.1/8 SS 4X20	SONDA TEMPERATURA 150 ATT.1/8 INOX 4x20 AMP MODUIS	
R04900775.1	KIT-TEMPERATURE PROBE 150°NTC ATT.1/8 SS 4X20 - 1P	KIT-SONDA TEMPERATURA 150 ATT.1/8 INOX 4x20- 1Pz	
04900810	TEMPERATURE PROBE 150 1/8 S/S CONN. 3x8	SONDA TEMPERATURA 150 ATT.1/8 INOX 3x8 AMP MODUIS	
07300001	L FITTING 1/8 M-M 459	RACCORDO L 1/8 M-M(dimens. L 24 mm)	
07300218	FITTING L 1/8 M-F 458	RACCORDO L 1/8 M-F 458	
07300243	FITTING 1/4M 1/8M GIGLER F.0,5	RACCORDO 1/4M-1/8M GIGLER F.0,5 INOX Aisi303	
07300244	FITTING 1/4M 1/8M + THREADED M8 Aisi303	RACCORDO 1/4M-1/8M + FILETT.M8 INOX Aisi303	
07300531	FITTING L 1/4 F 347	RACCORDO L 1/4 F CALZAM. 347	
07300777	S/S EXTENSION 1/8M 1/8F	PROLUNGA 1/8M 1/8F INOX	
R07300858	KIT-FITTING 1/4M-1/4M - 15Pcs	KIT-RACCORDO 1/4M-1/4M - 15Pz	
07300858	FITTING 1/4M-1/4M OT-57 USA	RACCORDO 1/4M-1/4M OT-57 USA	
07300864	FITTING 1/4M 1/8M + THREADED M6 Aisi316 + ORING POSI	RACCORDO 1/4M-1/8M + SEDE OR + F.M6 INOX Aisi316	
09500024	MANUAL THERMOSTAT 135°C TRIP FREE GREEN DRIPPIN	TERMOSTATO R.MAN. 135°C TRIP FREE GOCCIOLATURAVE	
09500026	AUTOMATIC THERMOSTAT 110°C	TERMOSTATO R.AUT. 110°C	
11600004	SILICONE PIPE 5x9 60Sh PEROX WHITE SEMITRASPAREN	TUBO SILICONE 5x9 70Sh PEROX TRASPARENTE(1mt=50gr)	
14100096	RESISTANCE 3/4 600W 115V	RESISTENZA 3/4 600W 115V INCOLOY800	
14100098	HEATING ELEMENT 3/4 600W 230V INCOLOY800	RESISTENZA 3/4 600W 230V INCOLOY800	
98004016	S/S FILTER D12	FILTRO INOX DIAM. 12	
R98004016	KIT-S/S FILTER D12 - 25Pcs	KIT-FILTRO INOX DIAM. 12 - 25Pz	
980300000013000001	COFFEE BOILER ASSEMBLY 1GR. 230V	ASSIEME CALDAIA CAFFE' 1GR. 230V	
980300000013000002	COFFEE BOILER ASSEMBLY 1GR. 115V	ASSIEME CALDAIA CAFFE' 1GR. 115V	
98030000002046	FLOWMETER T3 EXTERNAL GIGLER 0,5 SET	ASSIEME DOSATORE (GICAR) T3 "GIGLER ESTERNO F.0,5"	
98030000002047	FLOWMETER T3 EXTERNAL GIGLER 0,8 SET	ASSIEME DOSATORE (GICAR) T3 "GIGLER ESTERNO F.0,8"	
98031200	S/S WELDED COFFEE BOILER D42,5	CALDAIA SALD. ACCIAIO INOX D.42,5 CAFFE'	
98031264	COLD WATER CROSSPIECE	CROCIERA ACQUA FREDDA EAGLE ONE 1GR.	
98031266	DOSER PIPE - COFFEE BOILER	TUBO DOSATORE - CALDAIA CAFFE' EAGLE ONE 1GR	
98031272	COFFEE BOILER PIPE - DISPENSING GROUP	TUBO CALDAIA CAFFE' - GR.EROG.EAGLE ONE 1GR.	
98110001	RETURN VALVE 1/8 F-FOT-58	VALVOLA RITEGNO COMPL. 1/8 F-F OT-58	
R98110001	KIT-RETURN VALVE 1/8 F-F - 3Pcs	KIT-VALVOLA RITEGNO COMPL. 1/8 F-F - 3Pz	
98120001	NEPLAX VITON 16,5 BAR VALVE 1/8 HOSE CLAMP	VALVOLA NEPLAX VITON 16,5 BAR 1/8 - PORTAGOMMA	
R98120001	KIT-NEPLAX VITON 16,5 BAR VALVE 1/8 HOSE CLAMP - 2P	KIT-VALVOLA NEPLAX VITON 16,5 BAR 1/8 - PORTAGOMMA	
07300125	GIGLEUR M8x8 F.0,8 OT-57 +TEA	GIGLER M8x8 F.0,8 OT-57 +TEA	

### STEAM BOILER

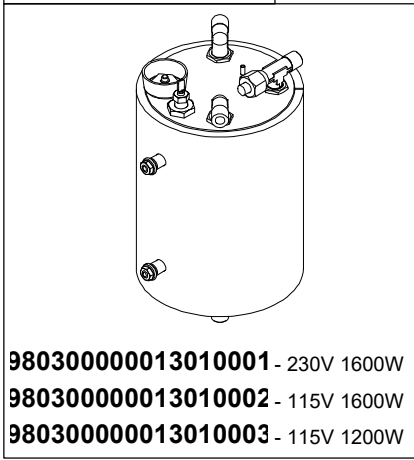

01000629

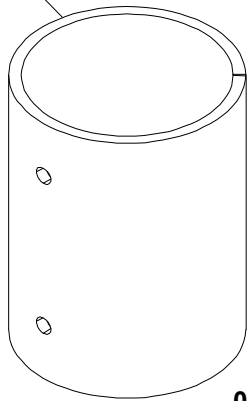

01000023  
03000202

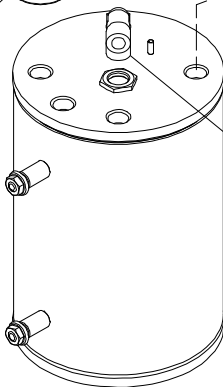

07300121

07300012

98031282

02280032

07300864

02290034

**14100103** 115V 1200W  
**14100105** 115V 1600W  
**14100104** 230V 1600W

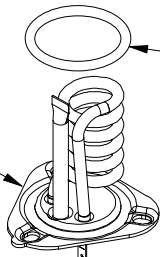

40000010

982600200

\*Specify version  
 Specificare versione

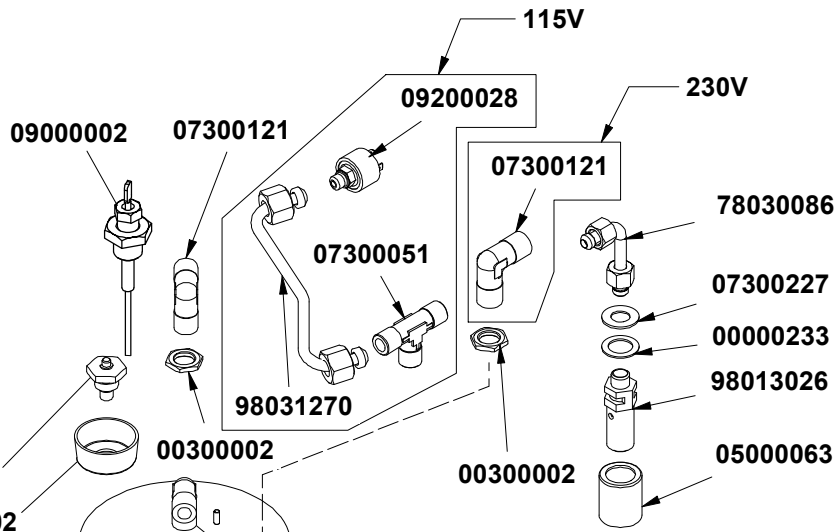

### SEL-LEVELING ASSEMBLY

07300001

**04100081** 115V  
**04100082** 230V

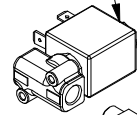

07300004

Old version  
 98031262

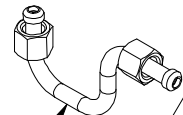
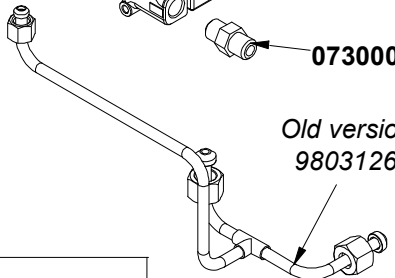

07300001

98031292

98110001

07300251

9803000001250

98031294

New version

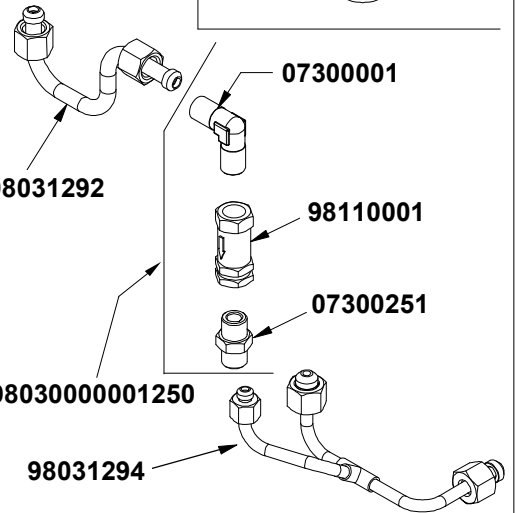

COD.	DESCRIPTION	DESCRIZIONE	VAL.
98030000013010001	BOILER SET EAGLE ONE 1GR 230V	ASS. CALDAIA EAGLE ONE 1GR. 230V	
98030000013010002	BOILER SET EAGLE ONE 1GR 115V	ASS. CALDAIA EAGLE ONE 1GR. 115V	
98030000013010003	BOILER SET EAGLE ONE 1GR 115V LOW POWER	ASS. CALDAIA EAGLE ONE 1GR. 115V BASSA POTENZA	
00000233	GALV WASHER M16 17x26x1	RONDELLA AQ M16 17x26x1 ZINC.	
00300002	BRASS NUT 1/4 D3 CH18	DADO OT 1/4 SPESS.3 CH18 AGG. 22.07.96	
R00300002	KIT-BRASS NUT 1/4 D3 - 15Pcs	KIT-DADO OT 1/4 SPESS.3 - 15Pz	
01000023	ANTI VACUUM VALVE	VALVOLINA SFIATO	
R01000023	KIT-ANTI VACUUM VALVE - 3Pcs	KIT-VALVOLINA SFIATO - 3Pz	
01000629	STEAM BOILER INSULATION	ISOLANTE CALDAIA VAPORE EAGLE ONE	
02280032	GASKET O RING 114 D15 EP 851	GUARN. OR 114 D.15 EP 851	
R02280032	KIT-GASKET O RING 114 D15 EP - 25Pcs	KIT-GUARN. OR 114 D.15 EP - 25Pz	
02290034	GASKET O RING 6187 D47x5,34 VITON FDA	GUARN. OR 6187 D.47x5,34 VITON FDA	
03000202	CONDENSATION TRAY MASTER	VASCHETTA RACCOGLI CONDENSA AGG. 07.06.97	
04100081	SOL. VALVE 2 WAYS 1/8-1/8 100/120V 50/60HZ	E.V. NC 2VIE 1/8-1/8 100/120V 50/60Hz VITON F1.2UL-CSA N5	
04100082	SOLENOID NC 2WAY 1/8-1/8 220-230V 50/60HZ VITON F1.2	E.V. NC 2VIE 1/8-1/8 220-230V 50/60Hz VITON F1.2	
05000063	SAFETY VALVE COVER PA6	COPRI VALVOLA SICUREZZA PA6	
R05000063	KIT-SAFETY VALVE COVER PA6 - 8Pcs	KIT-COPRI VALVOLA SICUREZZA PA6 - 8Pz	
07300001	L FITTING 1/8 M-M 459	RACCORDO L 1/8 M-M(dimens. L 24 mm)	
07300004	FITTING 1/8-1/8 DIRECT GAS	RACCORDO 1/8-1/8 GAS DIRITTO	
07300012	FITTING 1/4 1/4M-1/4M Aisi316	RACCORDO 1/4M-1/4M INOX Aisi316	
07300051	FITTING T 1/4 M-M-M CYLIN.	RACCORDO T 1/4 M-M-M CILIN.	
07300121	FITTING L 1/4 M-M CYLIND ADD. 18.02.97	RACCORDO L 1/4 M-M CILINDRICOAGG. 18.02.97	
R07300121	KIT-FITTING L 1/4 M-M CYLIND - 8Pcs	KIT-RACCORDO L 1/4 M-M CILINDRICO - 8Pz	
07300227	BRASS WASHER D.26X13,5X1,5 ADD.5.06.03	RONDELLA OT D.26x13,5x1,5 AGG.5.06.03	
07300251	FITTING 1/8 M-M HOLE 5,5 + THREADED M6 x L=11	RACCORDO 1/8 M-M FORO 5,5 + FILETT. M6 x L.=11	
07300864	FITTING 1/4M 1/8M + THREADED M6 Aisi316 + ORING POSI	RACCORDO 1/4M-1/8M + SEDE OR + F.M6 INOX Aisi316	
09000002	SELF LEVEL COMP. PROBE L=105 WITH THROAT	SONDA AUTOLIVELLO COMP. L=95 CON GOLA	
09200028	PRESSURE GAUGE 2,7 BAR 16A 230V	PRESSOSTATO 2,7 BAR 16A 230V	
14100103	S/S RESISTANCE FLANGE 1200W 115V - GREEN COLOUR	RESISTENZA FLANGIA INOX 1200W 115V - COLORE VERDE	
14100104	S/S RESISTANCE FLANGE 1600W 230V - NEUTRAL COLOU	RESISTENZA FLANGIA INOX 1600W 230V - COLORE NEUTR	
14100105	S/S RESISTANCE FLANGE 1600W 115V - BLUE COLOUR	RESISTENZA FLANGIA INOX 1600W 115V - COLORE BLU	
40000010	NUT M6 W/ WELDED GALV WASHER	DADO AQ M6 RONDELLA SALDATA ZINCATO	
78030086	LEVEL SOLENOID PIPE PREMIE'01 AURELIAII DGT/T3/CSA	TUBO EV. LIV. PREMIER'01 AURELIAII DGT/T3/CSA SOLO PE	
98013026	SAFETY VALVE C10 3 BAR 3/8 VITON 97/23/CE	VALVOLA SICUREZZA D7-S 3 BAR 1/4" VITON 97/23/CECAT.I	
98031262	SELF-LEVELING PIPE	TUBO AUTOLIVELLO EAGLE ONE 1GR **AD ESAURIMENTO	
98031270	BOILER PIPE - CSA PRESSURE SWITCH	TUBO CALDAIA - PRESSOSTATO CSA EAGLE ONE 1GR	
98031282	HOT WATER DRAFT HOSE	TUBO PESCAGGIO ACQUA CALDA EAGLE ONE 1GR.	
98031292	RETAINING VALVE TUBE - LEVEL E.V. E1 PRIMA	TUBO VALVOLA RITEGNO - E.V. LIVELLO E1 PRIMA	
98031294	RETAINING VALVE TUBE - BOILER E1 PRIMA	TUBO VALVOLA RITEGNO - CALDAIA E1 PRIMA	
9803000001250	RETAINING VALVE + AUTOLEVEL FITTINGS KIT	ASS. VALVOLA RITEGNO+RACCORDI AUTOLIVELLO E1 PRI	
98030000013010001	BOILER SET EAGLE ONE 1GR 230V	ASS. CALDAIA EAGLE ONE 1GR. 230V	
98030000013010002	BOILER SET EAGLE ONE 1GR 115V	ASS. CALDAIA EAGLE ONE 1GR. 115V	
98030000013010003	BOILER SET EAGLE ONE 1GR 115V LOW POWER	ASS. CALDAIA EAGLE ONE 1GR. 115V BASSA POTENZA	
982600200	HEATING ELEMENT THERMAL PROTECTION	RICAMBIO TERMOPROTETTORE X RESIST. EAGLE ONE	
98110001	RETURN VALVE 1/8 F-FOT-58	VALVOLA RITEGNO COMPL. 1/8 F-F OT-58	

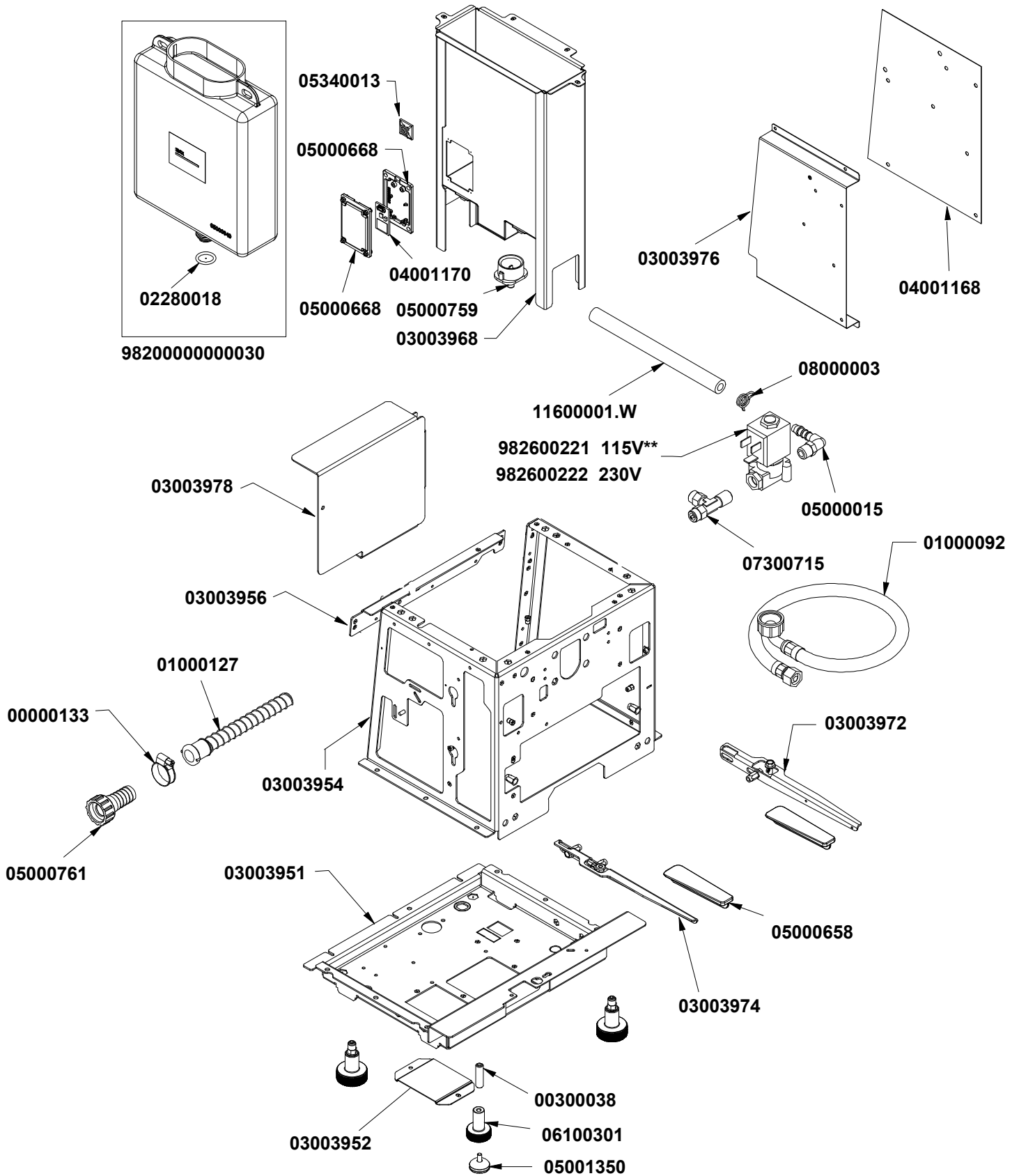

COD.	DESCRIPTION	DESCRIZIONE	VAL.
00000133	S/S CLIP WD12 16-25 C7 W2	FASCETTA INOX WD12 16-25 C7 W2	
00300038	S/S FH GRUB SCREW M10X35	GRANO INOX M10x35 PUNTA PIANA	
01000092	3/8F-3/4F90D WATER CHARGE PIPE 1,5mt + FILTER	TUBO CARICO ACQUA 1,5 mt EPDM 3/8F OTT - 3/4F 9GHIER	
R01000092	KIT-3/8F-3/4F90D WATER CHARGE PIPE 1,5mt+ FILTER-1Pc	KIT -TUBO CARICO ACQUA 1,5 MT EPDM 3/8F OTT3/4F 9 ** /	
01000127	DIRECT SLEEVE DISCHARGE TUBE D19 L=2m	TUBO SCARICO CON MANICOTTO DIRITTO D.19 L= 2 m	
R01000127	KIT-DIRECT SLEEVE DISCHARGE TUBE D19 L=2m - 2Pcs	KIT-TUBO SCARICO CON MANICOTTO DIRITTO D.19 L= 2 m-	
02280018	RED SILICON GASKET O RING Sh70	GUARN. OR R11 D19 SILICONE ROSSO Sh70	
03003951	FRAME BASE EAGLE ONE 1GR.	BASE TELAIO EAGLE ONE 1GR.	
03003954	SUPPORTING FRAME EAGLE ONE 1GR	TELAIO PORTANTE EAGLE ONE 1GR	
03003956	SUPERIOR BACKSIDE PLATE EAGLE ONE 1GR	LAMIERA SUPER. POSTERIORE 1GR EAGLE ONE	
03003968	WATER CONTAINER SUPPORT EAGLE ONE 1GR	SUPPORTO TANICA ACQUA EAGLE ONE 1GR.	
03003972	RIGHT PLATE GUIDE SHEET EAGLE ONE 1GR	LAMIERA GUIDA PIATTO DX EAGLE ONE 1GR	
03003974	LEFT PLATE GUIDE SHEET EAGLE ONE 1GR	LAMIERA GUIDA PIATTO SX EAGLE ONE 1GR	
03003976	BOARD SUPPORT EAGLE ONE 1GR	SUPPORTO CENTRALINA EAGLE ONE 1GR.	
03003978	ELECTRONIC COMPONENTS SUPPORT EAGLE ONE 1GR	SUPPORTO COMPONENTI ELETTRICI EAGLE ONE 1GR	
04001168	PVC MAIN BOARD PROTECTION	PROTEZIONE PVC CENTRALINA EAGLE ONE 1GR.	
04001170	TANK PRESENCE SENSOR EAGLE ONE 1GR	SENSORE PRESENZA TANICA EAGLE ONE 1GR.	
04100042	2WAY SOLENOID 1/8-1/8 220-230V50/60Hz F2 CE TH1xM4	E.V. NC 2VIE 1/8-1/8 220-230V 50/60Hz VITON F2 CEPIEDINO	
R04100042	KIT-2WAY SOLENOID 1/8-1/8 220-230V50/60Hz F2 CE - 1Pcs	KIT-E.V. NC 2VIE 1/8-1/8 220-230V 50/60Hz VITON F2- 1Pz	
04100043	2WAY SOLENOID 1/8-1/8 110-120V 60Hz F2 UL TH1xM4	E.V. NC 2VIE 1/8-1/8 110-120V 60Hz VITON F2 ULPIEDINO FIL	
05000015	TUBE FASTENING WES 6R 1/8	RACCORDO PORTATUBO WES 6R 1/8	
05000658	FLAT WATER DRIP TRAY EAGLE ONE	APPOGGIO PIATTO RACCOGLIACQUA EAGLE ONE	
05000668	CAPACITIVE PRESSURE SWITCH SUPPORT	SUPPORTO SENSORE CAPACITIVO EAGLE ONE 1GR.	
05000759	WATER CONTAINER COLLECTOR 5LT MICROBAR	COLLETORE CONTENITORE ACQUA 5LT MICROBAR	
05000761	STRAIGHT FITTING 3/4 Fx19 FOR EXHAUST PIPE	RACCORDO ATT. 3/4Fx19 DIRITTO x TUBO DI SCARICO	
05001350	MACHINE FOOT D40 H18 M8 MALE	PIEDE MACCHINA D.40 H=18+GOMM. INSERTO M8 MASCHIC	
05340013	SMALL BASE 19X19 FOR BAND WITH SCREW HOLE M4	BASETTA 19x19 PER FASCETTA CON FORO PER VITE M4	
06100301	FOOT MACHINE	PIEDE MACCHINA EAGLE ONE 1GR.	
07300715	T FITTING 1/8 M -FITTINGS.6 -FITTINGS.6	RACCORDO T 1/8 M -CALZAM.6 - CALZAM.6	
08000003	HOSE CLAMP D9,1	FASCETTA STRINGITUBO D9.1	
11600001.W	WHITE SILICONE PIPE 4x7,5 60Sh(1mt=41gr) PLATINICO SE	TUBO SILICONE BIANCO4x7,5 60Sh(1mt=41gr) PLATINICO SE	
98200000000030	WATER TANK SET 1,5 LT EAGLE ONE 1GR	ASS. TANICA ACQUA 1,5LT EAGLE ONE 1GR.	
982600221	SPARE PARTS KIT E.V. 115V E1 PRIMA	KIT RICAMBIO E.V. 115V E1 PRIMA	
982600222	SPARE PARTS KIT E.V. 230V E1 PRIMA	KIT RICAMBIO E.V. 230V E1 PRIMA	

04901521 115V/230V(AU/NZ)  
04901522 230V

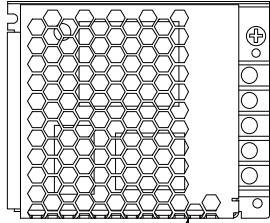

04000468

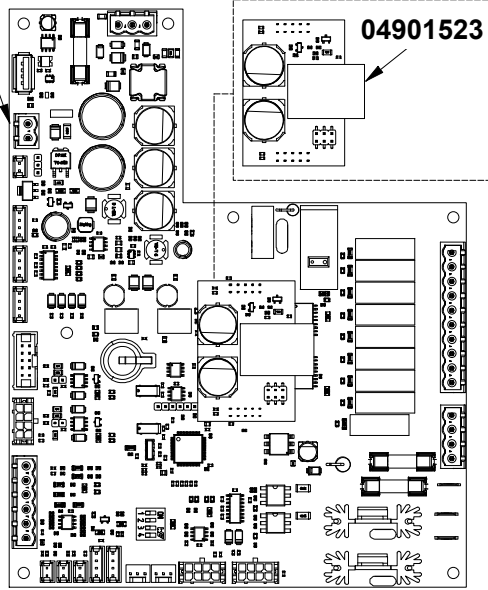

04901523



04000470

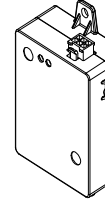

04901132

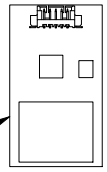

04001170

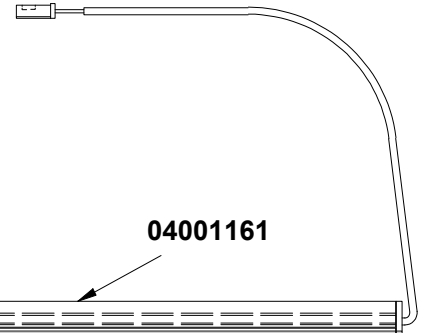

04001161

CODE	DESCRIPTION	DESCRIZIONE
04000244	PRESSURE TRANSDUCER CONN. CABLE	CAVO COLL. TRASDUTTORE PRESSIONE
04001128	WIRING HIGH VOLTAGE 115V	CABLAGGIO ALTA TENSIONE 115V
04001130	WIRING HIGH VOLTAGE 230V	CABLAGGIO ALTA TENSIONE 230V
04001131	WIRING LOW VOLTAGE	CABLAGGIO BASSA TENSIONE
04001144	SUPP. WIRING EASY CREAM	SUPPL. CABLAGGIO EASY CREAM
04001172	CABLE TANK SENSOR-MAIN BOARD	CAVO SENSORE TANICA-CENTRALINA
04001174	WIFI MODULE CABLE	CAVO MODULO WIFI

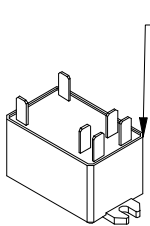

04200007 230V  
04200009 115V

04200112

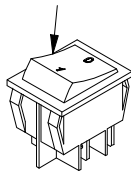

04200096

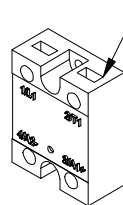

04001156\*\*

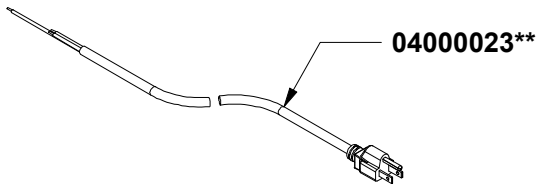
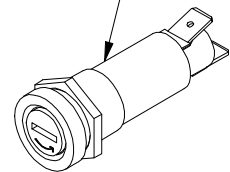

04000023\*\*

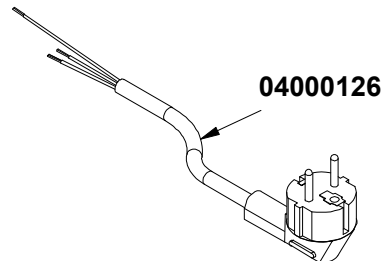

04000126

\*\*North America Market  
Mercato Nord America

COD.	DESCRIPTION	DESCRIZIONE	VAL.
04000023	SUPPLY CABLE UL AWG3X16 USA PLUG SHEATH 90°C 300	CAVO ALIM. AWG3x16 SJO 90°C 300V UL/CSA SPINA USADI	
04000126	ELECTRIC CABLE 2MT CE SCHUKO PLUG 90° 3X1,5	CAVO ELETTR. 2mt CE SPINA SCHUKO 90° 3x1,5 H05VV-F	
04000244	3POLE CONN CABLE RAST 2.5/MOLEX L = 800mm for PSTY	CAVO COLL.3P RAST 2,5/MOLEX L.800mm x TRASDUTTORIF	
04000468	TRANSFORMER 24VDC 50W OPTIONAL AURELIA18 LRS 50	TRASFORMATORE 24V 50W OPTIONALS AURELIA18LRS-50	
R04000468	KIT-TRANSFORMER 24VDC 50W Opt. - 1Pcs	KIT-TRASFORMATORE 24V 50W-1 PZ	
04000470	12VDC LED SPOT AURELIA WAVE	LED AURELIA18 12V	
R04000470	KIT-12VDC LED SPOT AURELIA WAVE-2Pcs	KIT -LED AURELIA18 12V-2PZ	
04001128	WIRING 115 HIGH VOLTAGE	CABLAGGIO 1GR EAGLE ONE 115V ALTA TENSIONE	
04001130	WIRING 230 HIGH VOLTAGE	CABLAGGIO 1GR EAGLE ONE 230V ALTA TENSIONE	
04001131	WIRING LOW VOLTAGE	CABLAGGIO 1GR EAGLE ONE BASSA TENSIONE	
04001144	SUPPLEMENT WIRING FOR EASYCREAM EAGLE ONE 1GR	SUPPL. CABLAGGIO EASY CREAM EAGLE ONE 1GR.	
04001156	CSA THERMAL DISJUNCER	PORTAFUSIBILE 15-20A	
04001161	STRIP LED EAGLE ONE 1GR.	STRIP LED EAGLE ONE 1GR.	
04001170	TANK PRESENCE SENSOR EAGLE ONE 1GR	SENSORE PRESENZA TANICA EAGLE ONE 1GR.	
04001172	CONN. CABLE TANK SENSOR-MAIN BOARD	CAVO COLL. SENSORE PRESENZA TANICA - CENTRALINA	
04001174	WIFI MODULE CABLE-MAIN BOARD	CAVO MODULO WIFI2020 - CENTR. EAGLE ONE 1GR.	
04200007	POWER RELAY 30A 230V BIPOLAR	RELE' DI POTENZA 30A 230V BIPOLARE	
R04200007	KIT-POWER RELAY 30A 230V BIPOLAR - 1Pcs	KIT-RELE' DI POTENZA 30A 230V BIPOLARE - 1Pz	
04200009	POWER RELAY 30A 115V BIPOLAR	RELE' DI POTENZA 30A 115 V BIPOLARE	
04200096	STATIC RELAY 25A 250V 1OUT	RELE' STATICO 25A 250V 1out	
R04200096	KIT-STATIC RELAY 25A 250V 1OUT-1Pcs	KIT -RELE' STATICO 25A 250V 1OUT-1PZ** AD ESAURIMENT	
04200112	RED LIGHT 0/1 BIPOLAR SWITCH UL 16A	INTERRUTTORE BIPOLARE LUMINOSO ROSSO 0/1RETTAN	
04901132	MODULO WIFI2020	MODULO WIFI2020	
04901521	MAIN BOARD EAGLE ONE 1GR. USA/CAN - AUS/NZ	CENTRALINA EAGLE ONE 1GR. USA/CAN - AUS/NZ	
04901522	CENTRAL BOARD EAGLE ONE 1GR.	CENTRALINA EAGLE ONE 1GR.	
04901523	Bluetooth MODULE EAGLE ONE 1GR.	MODULO Bluetooth EAGLE ONE 1GR.(x centralina 04901522)	



INSPIRED BY YOUR PASSION.

Simonelli Group s.p.a.  
Via E. Betti, 1 - 62020 Belforte  
del Chienti - (MC) Italy  
Tel. +39 0733.950243 - Fax +39  
0733.850247  
e-mail: [info@victoriaarduino.com](mailto:info@victoriaarduino.com)  
com [www.victoriaarduino.com](http://www.victoriaarduino.com)